

**ROHS**

ISO 9001  
ISO 14001

single-packing sticker

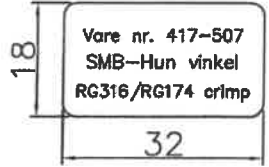

single-packing zipper bag

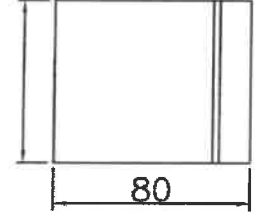

10pcs PE bag

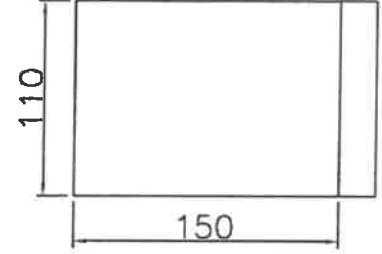

10pcs sticker

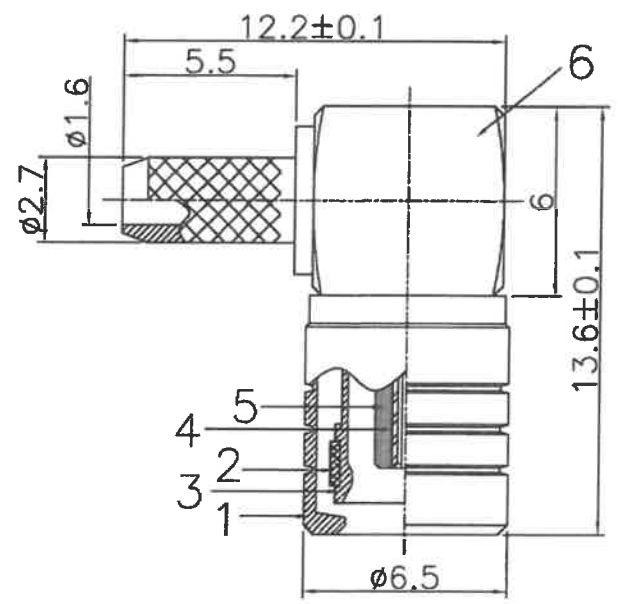
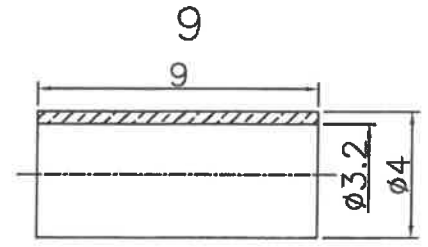
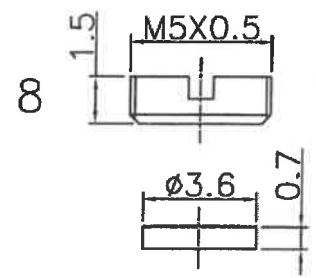
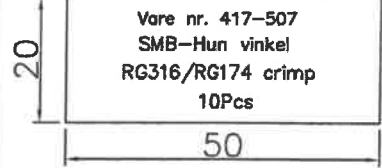

1. Temperature range : -40°C~125°C
2. Impedance : 50Ω
3. Gain : 0~6GHz
4. Dielectric withstand voltage : 750V
5. Insulation resistance : 1000MΩ
6. Contact resistance : inner conductor 5mΩ  
outer conductor 2.5mΩ
7. Voltage assist ratio : ≤1.2(0~6GHz)
8. Durability : 500\*
9. Unit : mm

9	FERRULE	BRASS / GOLD	1
8	SPIGOT	BRASS / GOLD	1
7	INSULATOR	PTFE / WHITE	1
6	BODY	BRASS / GOLD	1
5	INSULATOR	PTFE / WHITE	1
4	PIN	BRASS / GOLD	1
3	BODY	BRASS / GOLD	1
2	WASH	Be Cu / GOLD	1
1	SHELL	BRASS / GOLD	1
NO	DESCRIPTION	MATERIAL / FINISH	QTY

Material:		Treatment:		TRANSVOICE			
Drawer	Design	Aprov	Tolerance	Unit: mm		TITLE	RP SMB M RA for 316
			X=±0.5 .X=±0.2 .XX=±0.1 .XXX=±0.05	Ver: A	Scale 5:1	Model NO	417-507
Part NO	XP-CR1058-5993			File NO: QR0402	Drawing NO	100-27001-120	