

NO	DESCRIPTION	MATERIAL	Q'TY	FINISH	REMARK
1	BODY 1	BRASS	1	GOLD	B-SMA0155-G
2	INSULATION 1	TEFLON	1	TEFLON	I-0053T
3	PIN	BE CU	1	GOLD	P-SMB0145-G
4	BODY 2	BRASS	1	GOLD	B-SMB0479-G
5	BODY 3	BRASS	1	GOLD	B-SMB0245-G
6	INSULATION 2	TEFLON	1	TEFLON	I-0136T
7	WASHER 1	BRASS	1	GOLD	W-0023-G
8	RING	BRASS	1	GOLD	R-0002-G

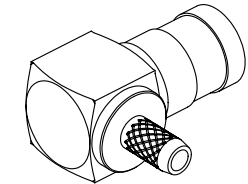

(Recommended Stripping Dimension)

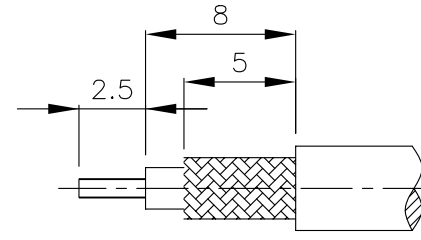
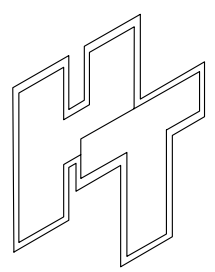
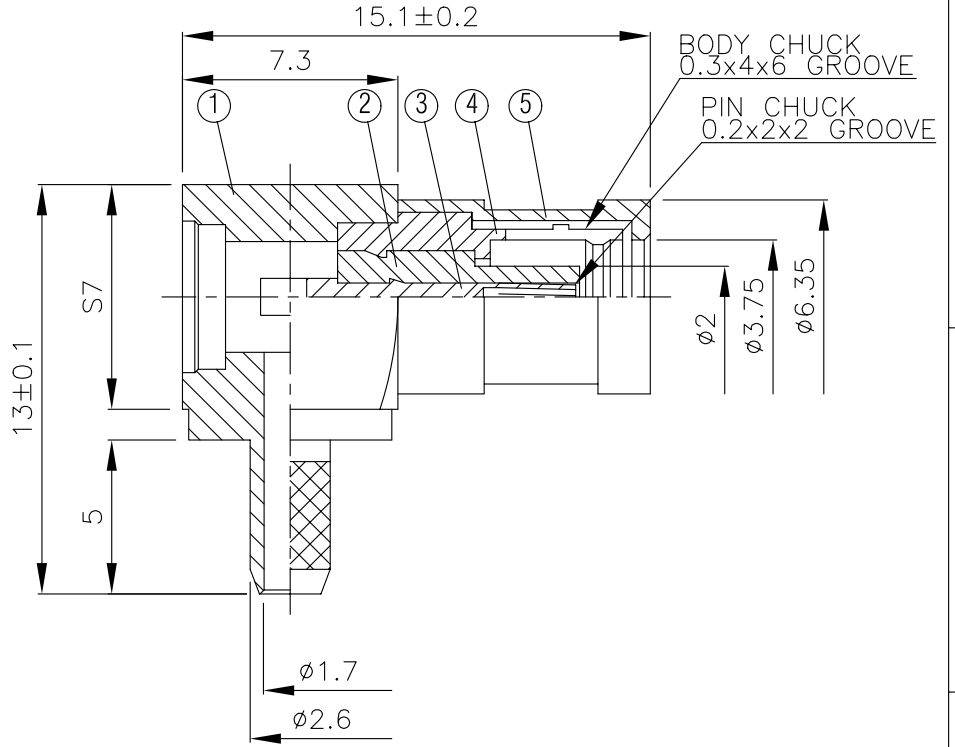
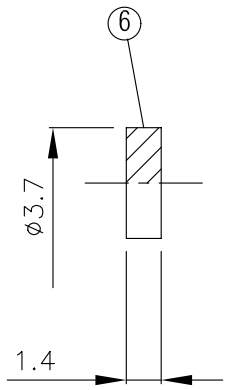
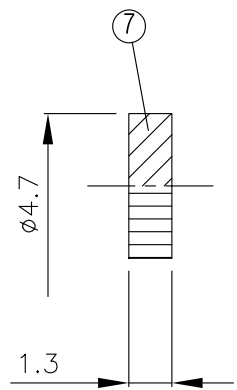
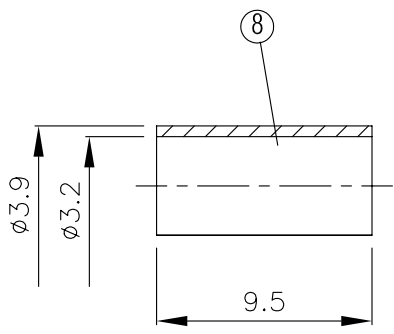

HUS-TSAN GROUP CO., LTD.
P.O.BOX 40-76.TAINAN.TAIWAN,R.O.C.
TITLE SMB FEMALE ANGLE CRIMP FOR RG316U,174U
PART NO. SMB-03LV1-TGG
DRAWING NO. SMB-03LV1-TGG

DRAWN	MARY	DATE	91.03.06
CHECKED	黃巧君	DATE	91.03.06
Q.A.	蘇姿潔	DATE	
APPROVAL	徐燦霖	DATE	
REVISION		DATE	

DIMENSIONS ARE IN MILLIMETERS			
UNLESS OTHERWISE SPECIFIED TOLERANCE			
0.5-5=±0.2	120-315=±1		
5-30=±0.4	315-1000=±1.6		
30-120=±0.6	1000-2000=±2.4		
SCALE	4:1	SIZE	A

REVISION	
DESCRIPTION	ENGINEER