

*Varenr: 202-884*

*Specification*

- 1. Product: L54+RG316+MCX M RA*
  - 2. Frequency: 698~2700 MHz*
  - 3. VSWR: 2.4:1*
  - 4. Gain: 2.5~3dB*
  - 5. Impedance: 50  $\Omega$*
  - 6. Cable: RG316U*
  - 7. Connector: MCX M RA*
- ✘RoHS Compliant*

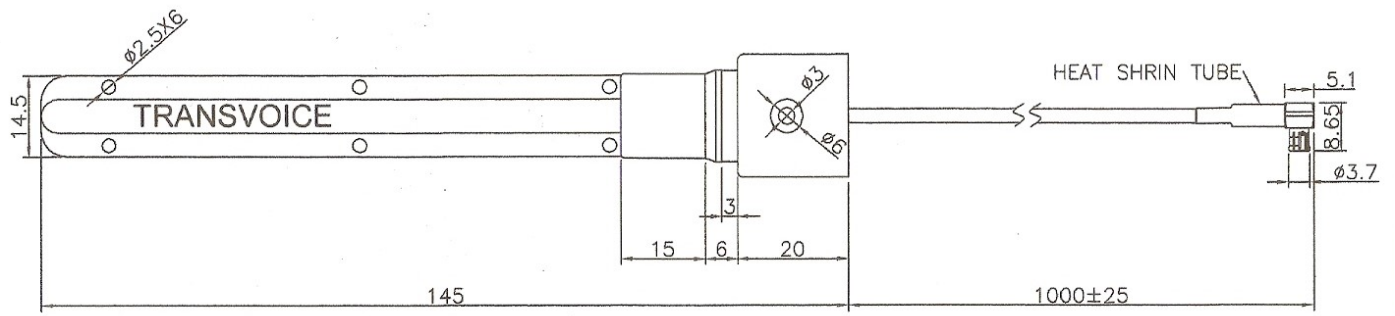



## ELECTRICAL

Frequency (MHz)	Gain (dB)	Efficiency (%)
700	2.85	46.56
800	2.48	42.46
900	2.18	41.59
1800	2.05	48.98
1900	2.87	54.95
2100	4.67	76.38
2400	0.89	73.79
2600	2.96	86.9
2700	3.46	68.55

# Test Data

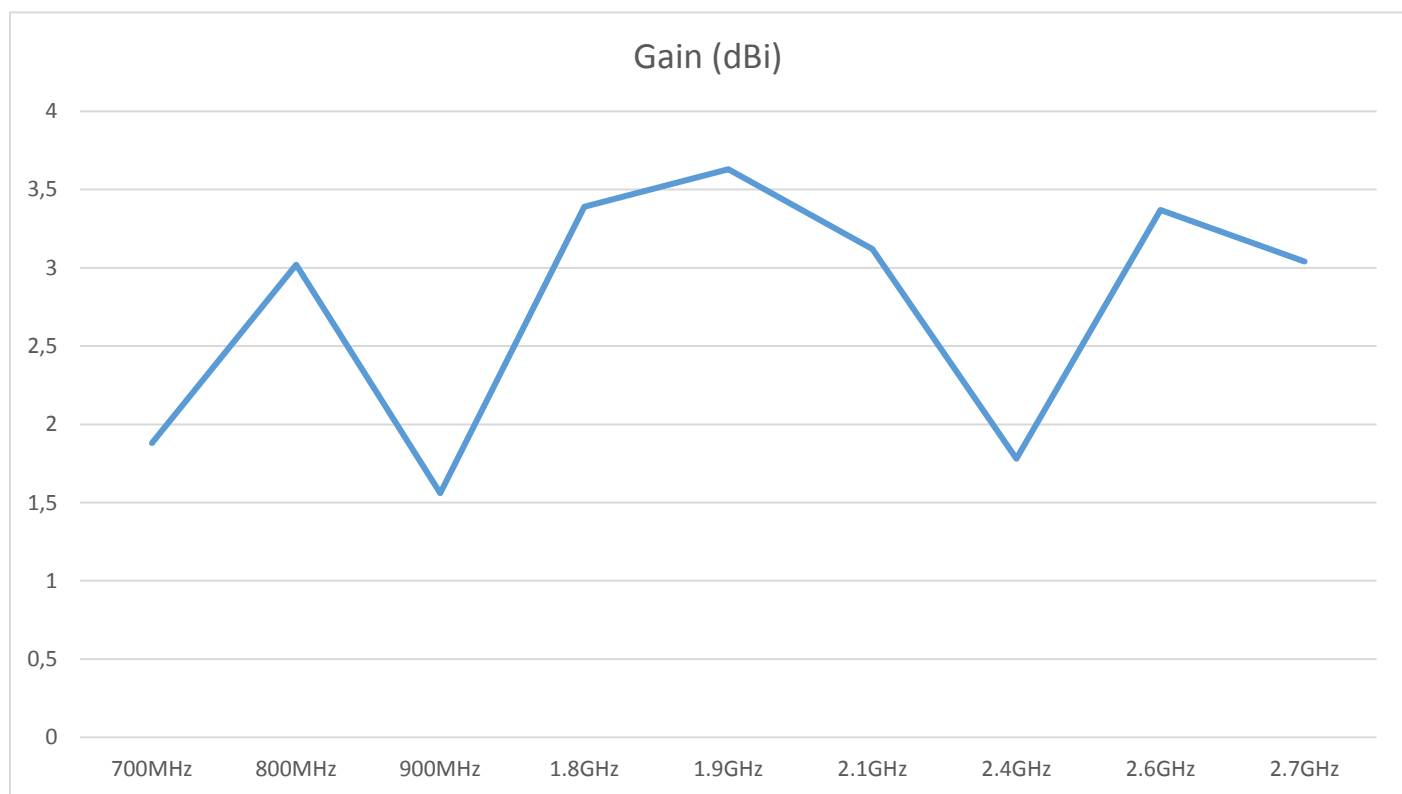
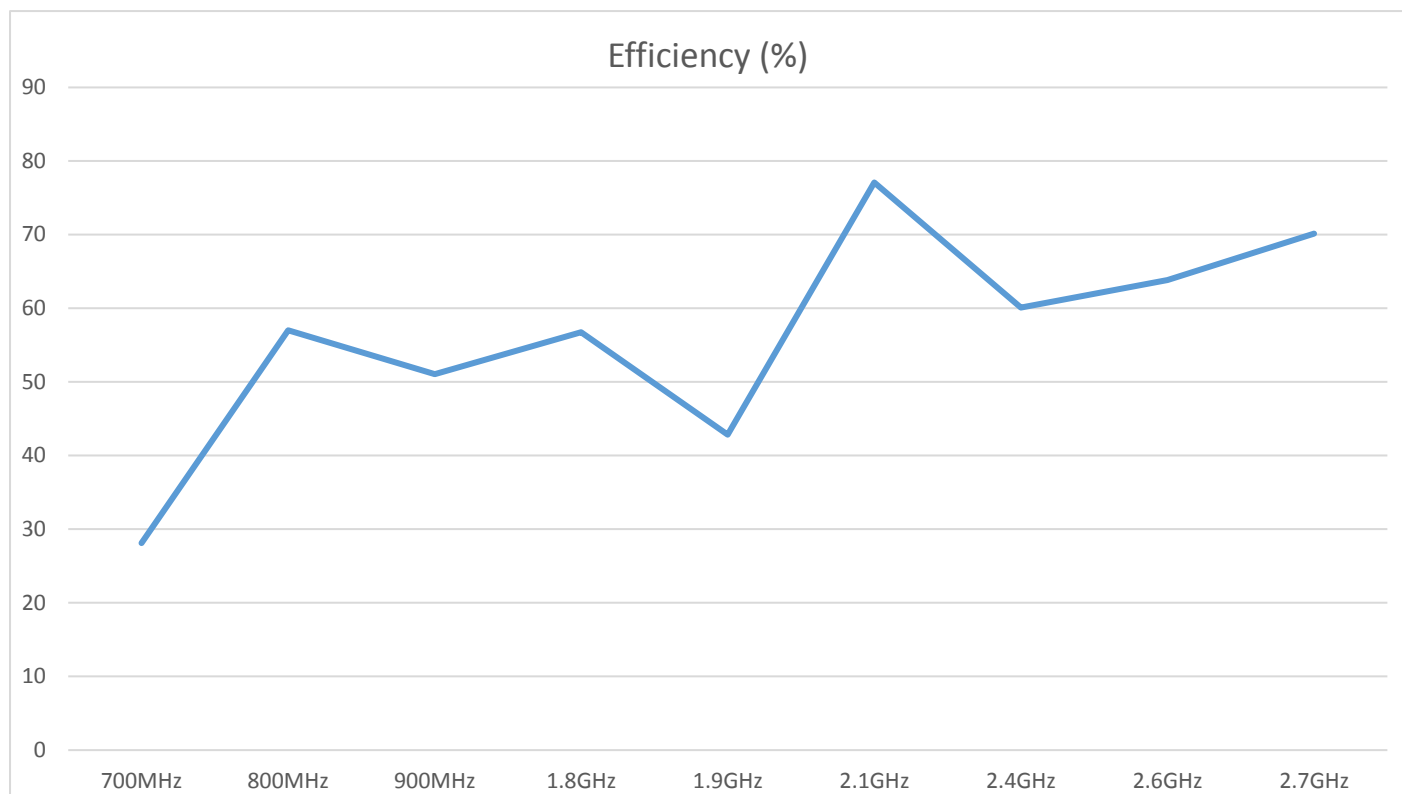

Total\_3D\_Side View 1\_700MHz

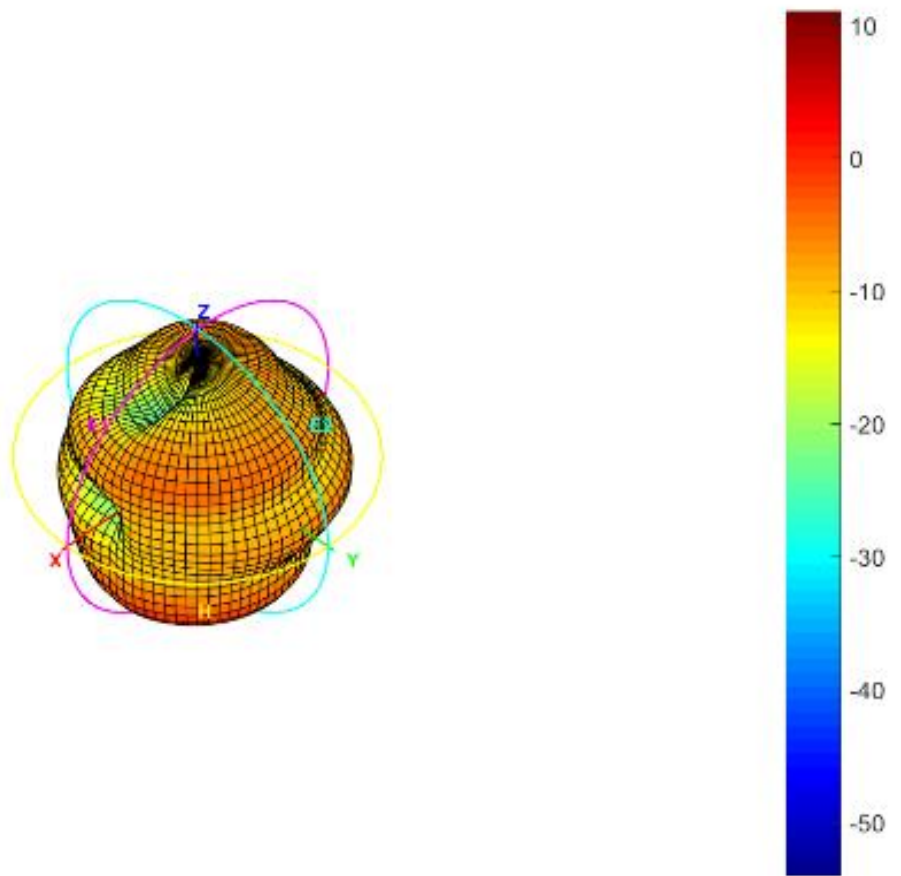

Total\_3D\_Side View 1\_800MHz

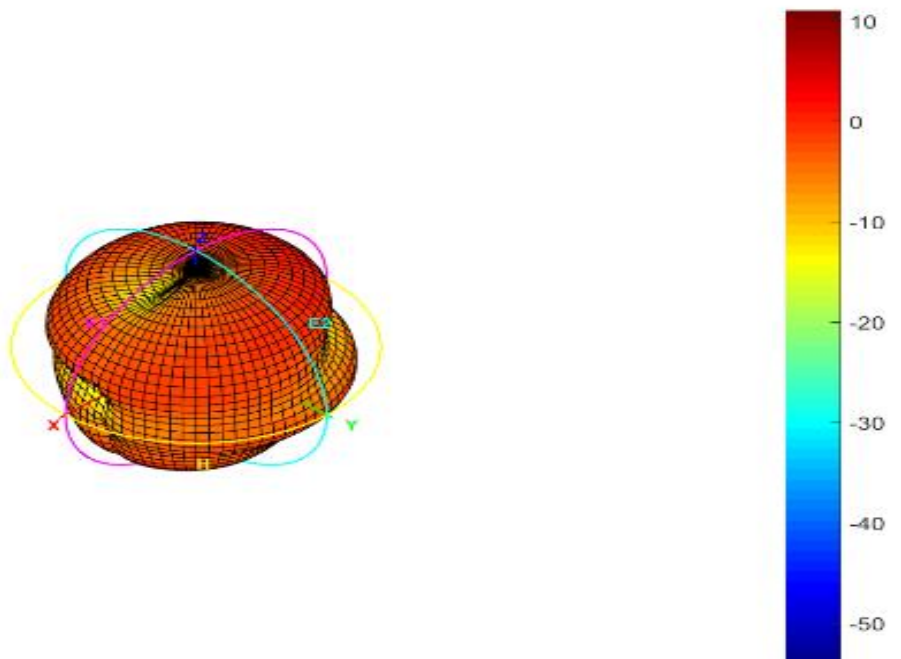

Total\_3D\_Side View 1\_900MHz

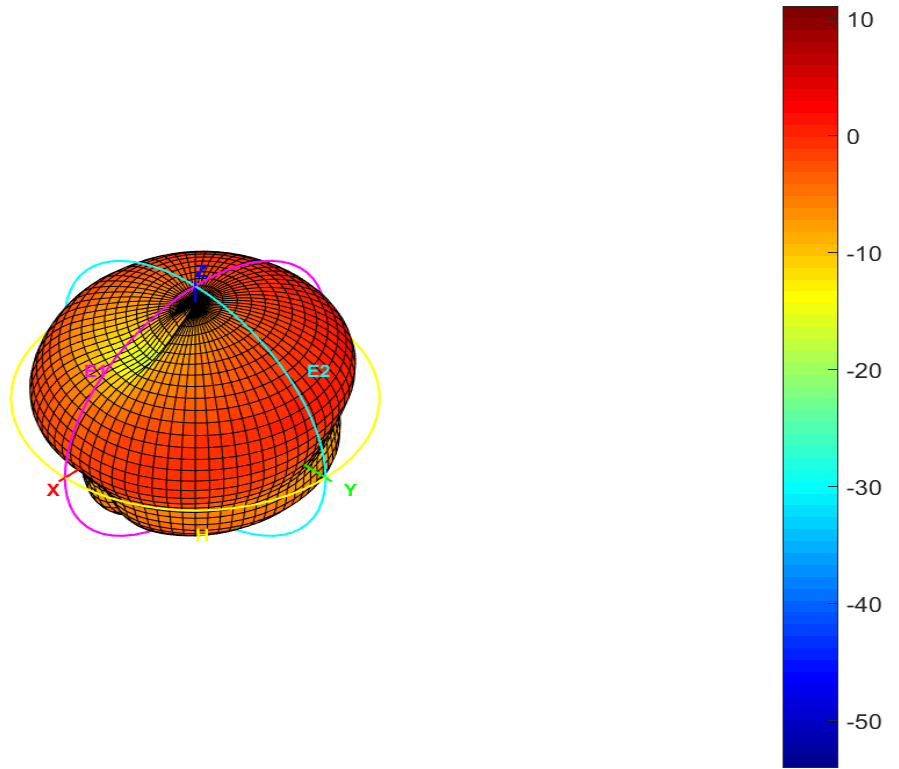

Total\_3D\_Side View 1\_1.8GHz

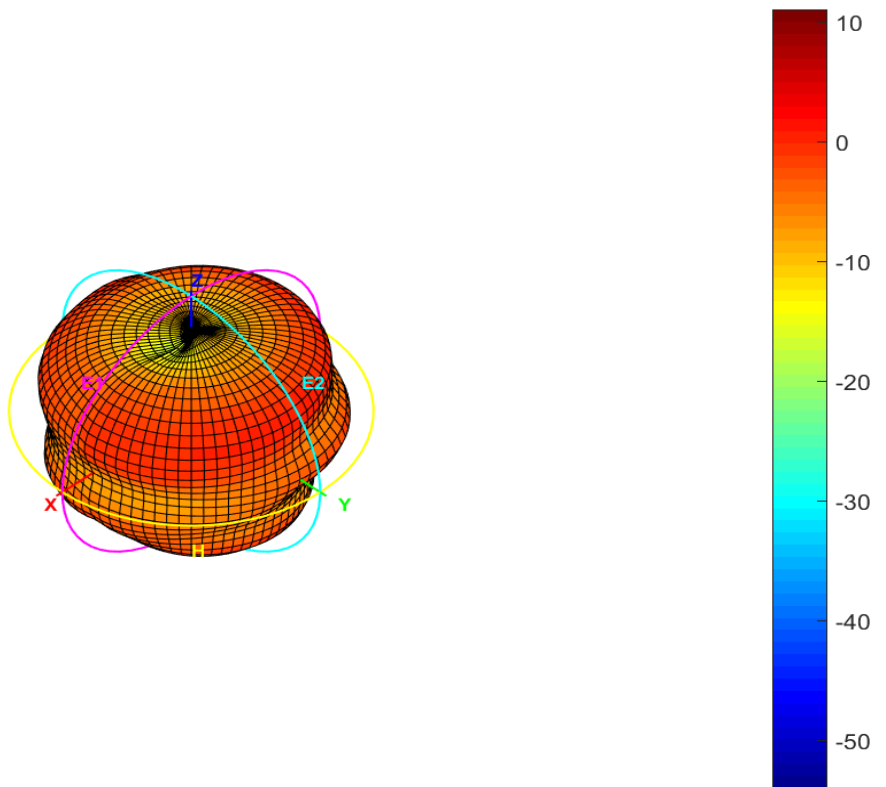

Total\_3D\_Side View 1\_1.9GHz

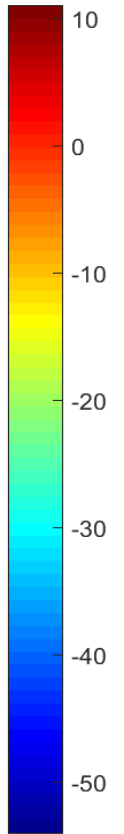
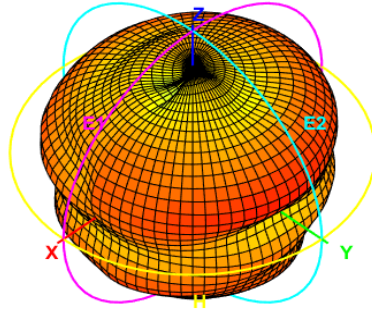

Total\_3D\_Side View 1\_2.1GHz

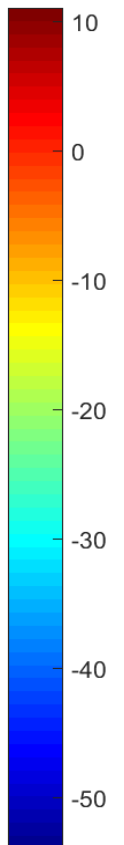
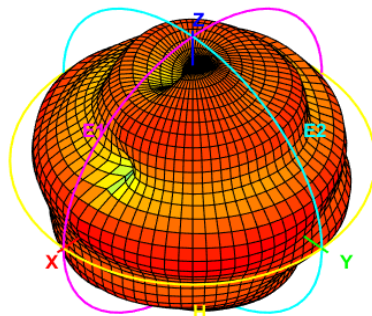

Total\_3D\_Side View 1\_2.4GHz

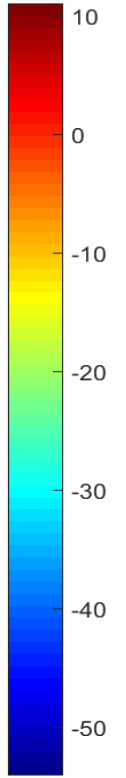
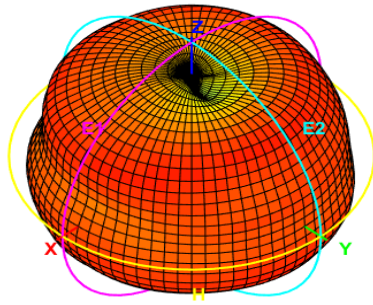

Total\_3D\_Side View 1\_2.6GHz

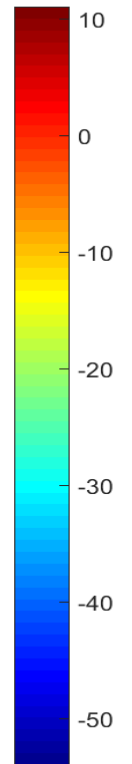
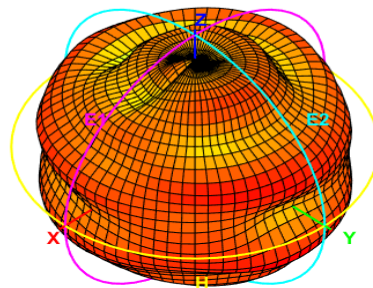



Total\_3D\_Side View 1\_2.7GHz

